

Typical Applications

The HMC908LC5 is ideal for:

- Point-to-Point and Point-to-Multi-Point Radio
- Military Radar, EW & ELINT
- Satellite Communications
- Maritime & Mobile Radio

Functional Diagram

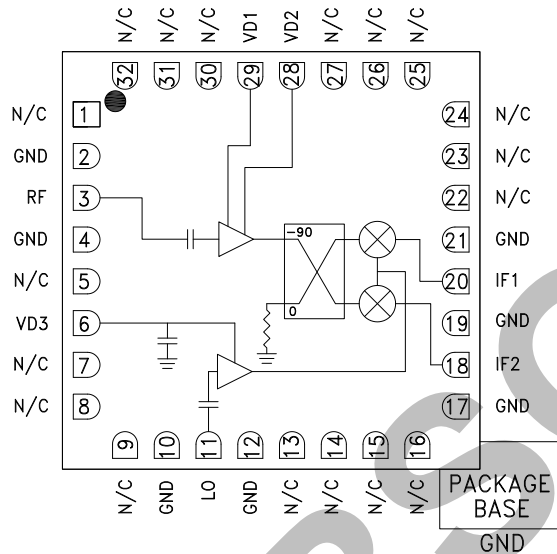

Features

- Conversion Gain: 11 dB
- Image Rejection: 25 dB
- LO to RF Isolation: -50 dB
- Noise Figure: 2.2 dB
- Input IP3: +2 dBm
- 32 Lead 5x5mm Ceramic SMT Package: 25mm²

General Description

The HMC908LC5 is a compact GaAs MCM I/Q downconverter in a leadless RoHS compliant SMT ceramic package. This device provides a small signal conversion gain of 11 dB with a noise figure of 2.2 dB and 25 dB of image rejection. The HMC908LC5 utilizes an LNA followed by an image reject mixer which is driven by an LO buffer amplifier. The image reject mixer eliminates the need for a filter following the LNA, and removes thermal noise at the image frequency. I and Q mixer outputs are provided and an external 90° hybrid is needed to select the required sideband. The HMC908LC5 is a much smaller alternative to hybrid style image reject mixer downconverter assemblies, and it eliminates the need for wire bonding by allowing the use of surface mount manufacturing techniques.

Electrical Specifications, $T_A = +25\text{ }^\circ\text{C}$, $IF = 100\text{ MHz}$, $LO = 0\text{ dBm}$, $VD1 = VD2 = 3\text{V}$, $VD3 = 5\text{V}^*$

Parameter	Min.	Typ.	Max.	Units
Frequency Range, RF	9 - 12			GHz
Frequency Range, LO	5.5 - 15.5			GHz
Frequency Range, IF	DC - 3.5			GHz
Conversion Gain (As IRM)	8	11		dB
Noise Figure		2.2		dB
Image Rejection	15	25		dB
1 dB Compression (Input)		-5		dBm
LO to RF Isolation	40	50		dB
LO to IF Isolation	5	10		dB
IP3 (Input)	-3	2		dBm
Amplitude Balance		±1		dB
Phase Balance		±6		Deg
Supply Current (ID1 + ID2)		60	88	mA
Supply Current (ID3)		100	120	mA

*Data taken as IRM with external IF Hybrid



Data Taken As IRM With External IF Hybrid

Conversion Gain vs. Temperature

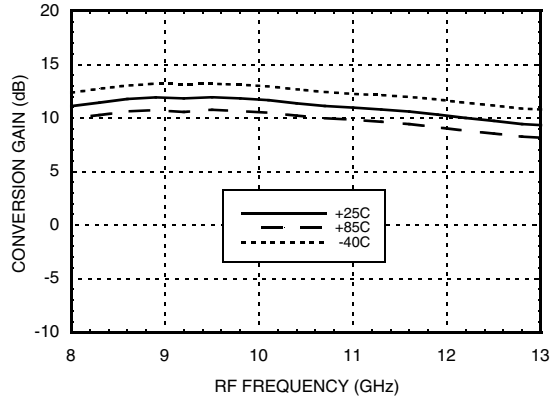
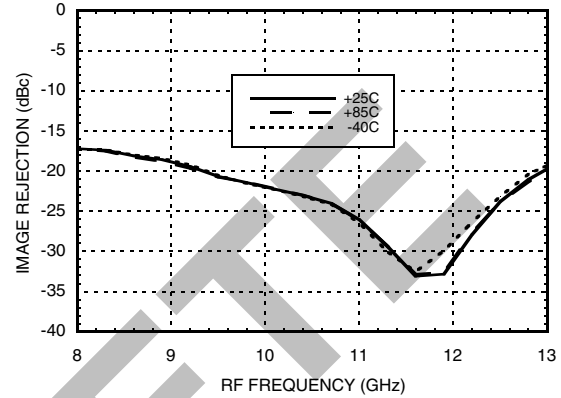
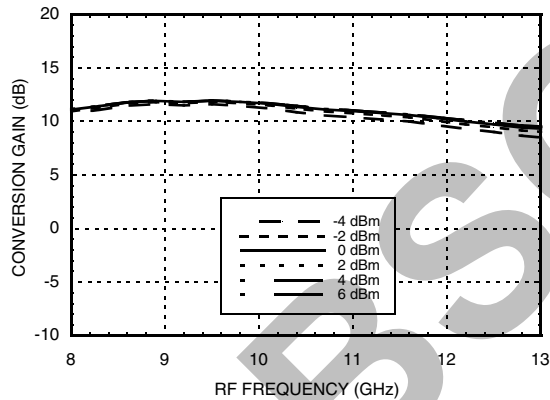

Image Rejection vs. Temperature



Conversion Gain vs. LO Drive



Return Loss

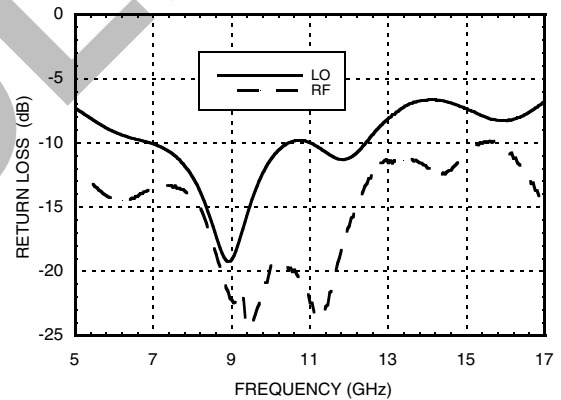

Input P1dB vs. Temperature

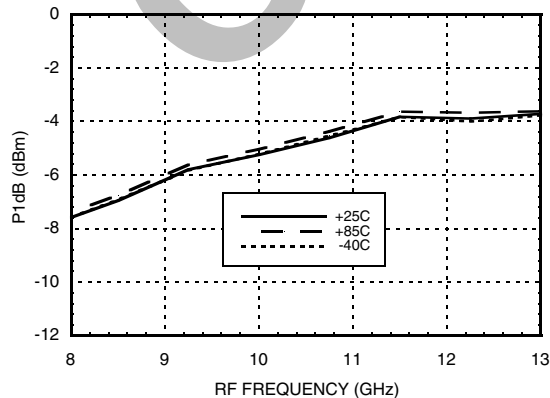

Input IP3 vs. LO Drive

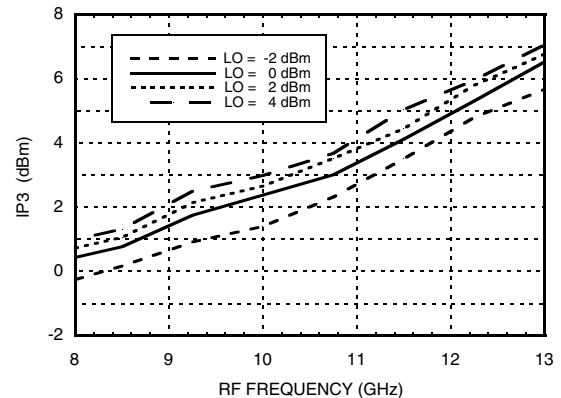



Quadrature Channel Data Taken Without IF Hybrid

Isolations

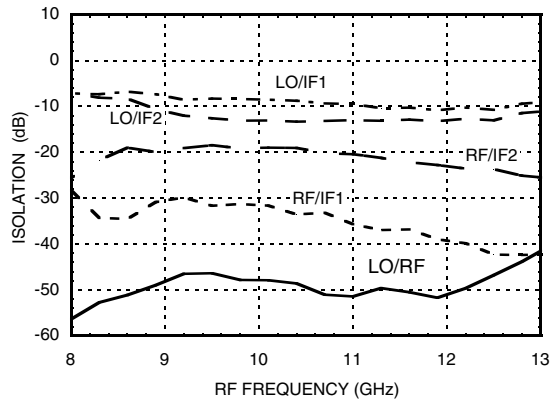

IF Bandwidth*

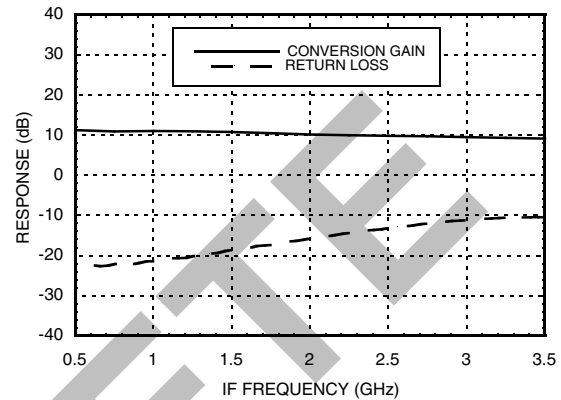

Amplitude Balance vs. LO Drive

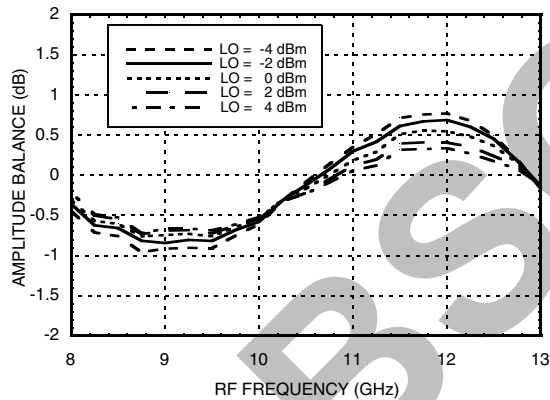

Phase Balance vs. LO Drive

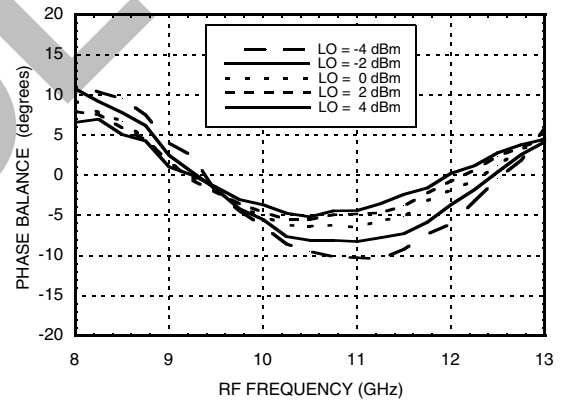

Noise Figure vs. LO Drive,
LO Frequency = 10 GHz

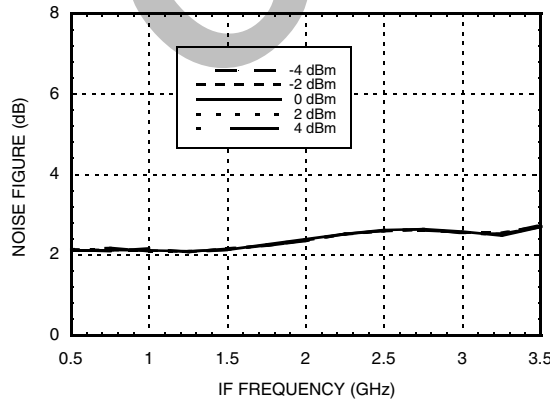

Noise Figure vs. LO Drive,
IF Frequency = 100 MHz

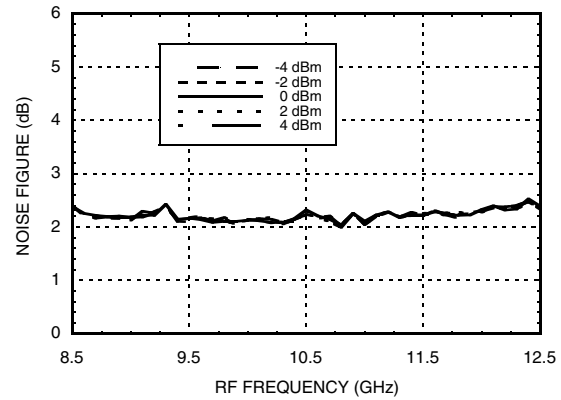

* Conversion gain data taken with external IF hybrid, LO frequency fixed at 10 GHz and RF varied

MxN Spurious Outputs

mRF	nLO				
	0	1	2	3	4
0	xx	27	36	37	92
1	16	0	34	68	61
2	92	66	57	70	92
3	92	92	81	57	92
4	92	92	92	92	92

RF = 10.6 GHz @ -20 dBm

LO = 10.5 GHz @ 0 dBm

Data taken without IF hybrid

All values in dBc below IF power level.

Absolute Maximum Ratings

RF	+5 dBm
LO Drive	+20 dBm
VD1, VD2	4.0V
VD3	5.5V
Channel Temperature	150°C
Continuous Pdiss (T=85°C) (derate 9.56 mW/°C above 85°C)	0.65 W
Thermal Resistance (R _{TH}) (channel to package bottom)	71 °C/W
Storage Temperature	-65 to +150 °C
Operating Temperature	-55 to +85 °C
ESD Sensitivity (HBM)	Class 0, 150V

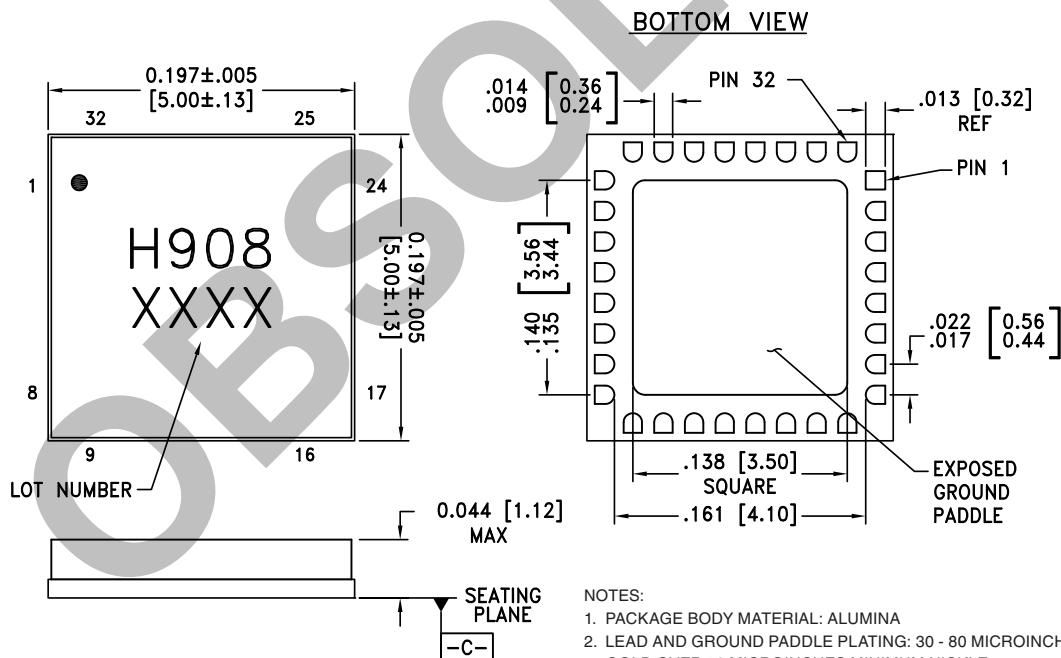
**ELECTROSTATIC SENSITIVE DEVICE
OBSERVE HANDLING PRECAUTIONS**
Outline Drawing

NOTES:

1. PACKAGE BODY MATERIAL: ALUMINA
2. LEAD AND GROUND PADDLE PLATING: 30 - 80 MICROINCHES GOLD OVER 50 MICROINCHES MINIMUM NICKLE
3. DIMENSIONS ARE IN INCHES [MILLIMETERS]
4. LEAD SPACING TOLERANCE IS NON-CUMULATIVE
5. PACKAGE WARP SHALL NOT EXCEED 0.05mm DATUM
6. ALL GROUND LEADS AND GROUND PADDLE MUST BE SOLDERED TO PCB RF GROUND

Package Information

Part Number	Package Body Material	Lead Finish	MSL Rating	Package Marking ^[1]
HMC908LC5	Alumina	Gold	MSL3 ^[2]	H908 XXXX

[1] 4-Digit lot number XXXX

[2] Max peak reflow temperature of 260 °C

Pin Descriptions

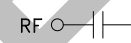
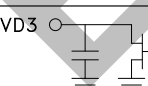
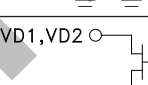
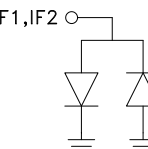
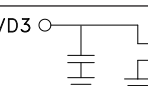
Pin Number	Function	Description	Interface Schematic
1, 5, 7 - 9, 13 - 16, 22 - 27, 30 - 32	N/C	The pins are not connected internally; however, all data shown herein was measured with these pins connected to RF/DC ground externally.	
2, 4, 10, 12, 17, 19, 21	GND	These pins and ground paddle must be connected to RF/DC ground.	
3	RF	This pin is AC coupled and matched to 50 Ohms.	
6	VD3	Power supply for LO amplifier.	
28, 29	VD1, VD2	Power supply for RF LNA.	
18	IF2	This pin is DC coupled. For applications not requiring operation to DC, this port should be DC blocked externally using a series capacitor whose value has been chosen to pass the necessary frequency range. For operation to DC, this pin must not sink / source more than 3 mA of current or part non-function and possible failure will result.	
20	IF1		
11	LO	This pin is AC coupled and matched to 50 Ohms.	

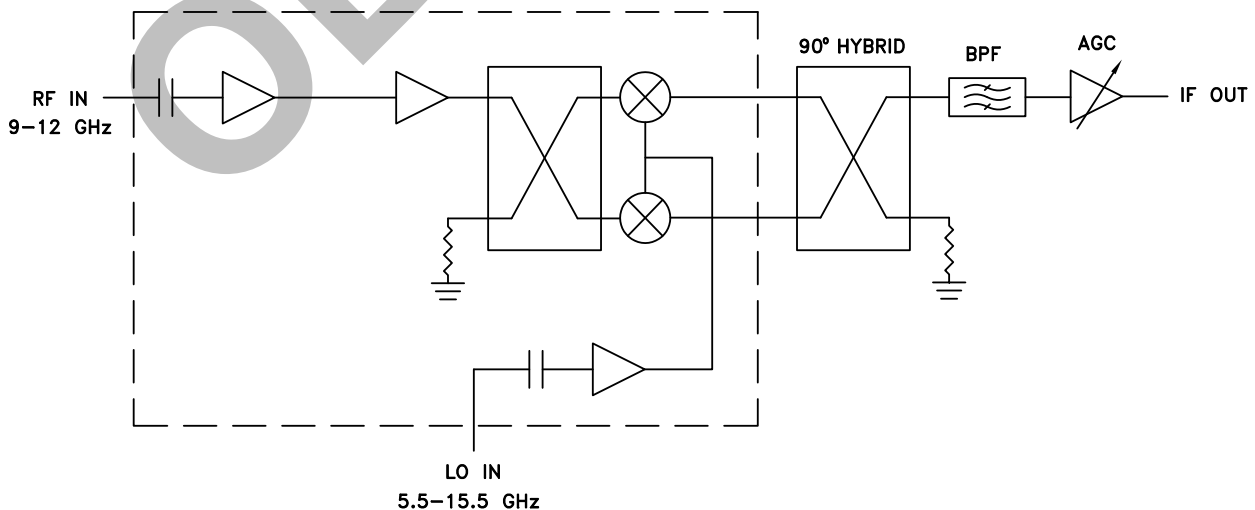
Typical Application

Note: LSB and USB is determined by GND on Hybrid

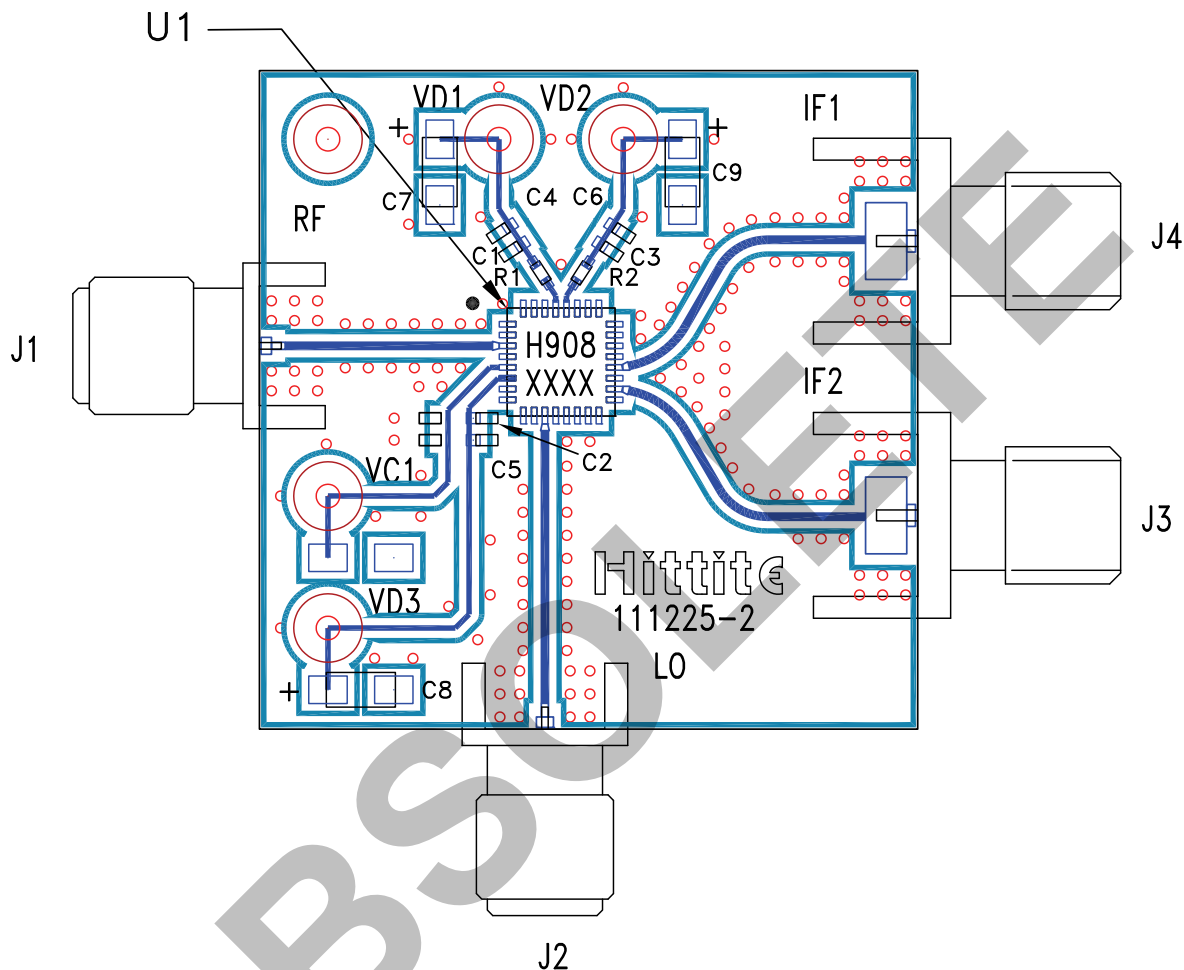
Evaluation PCB

List of Materials for Evaluation PCB 111227 [1]

Item	Description
J1, J2	PCB Mount SMA RF Connector, SRI
J3, J4	PCB Mount SMA Connector, Johnson
J5 - J7	DC Pin
C1, C2, C3	100 pF Capacitor 0402, Pkg.
C4, C5, C6	1000 pF Capacitor 0402, Pkg.
C7, C8, C9	2.2 μ F Capacitor, Tantalum Case A
R1, R2	0 Ohm Resistor, 0402 Pkg.
U1	HMC908LC5
VC1	N/C
PCB [2]	111225 Evaluation Board

[1] Reference this number when ordering complete evaluation PCB

[2] Circuit Board Material: Rogers 4350

The circuit board used in the application should use RF circuit design techniques. Signal lines should have 50 Ohm impedance while the package ground leads and exposed paddle should be connected directly to the ground plane similar to that shown. A sufficient number of via holes should be used to connect the top and bottom ground planes. The evaluation circuit board shown is available from Hittite upon request.